

### CARATTERISTICHE

Catenaccio **basculante**

Funzioni: scrocco / rullo regolabile con catenaccio, solo catenaccio, gancio

Reversibile

1 o 3 punti di chiusura

Asole per il **montaggio facilitato delle aste** interne / esterne

Coprifrontale in **acciaio inox**

Interasse 85 o 92 mm

Entrate 25, 30, 35 mm

Abbinabile a tutti i tipi di cilindri (opzionali):

**Serie 115-116, RK6 e Spillo**

### FEATURES

*Tilting dead bolts*

*Functions: spring latch / adjustable roller latch and dead bolt, dead bolt only, hook dead bolt*

*Reversible*

*1 or 3 locking points*

*Slots for **easy rod fixing***

***Stainless steel** forend cover*

*Centre distance 85 o 92 mm*

*Backsets 25, 30, 35 mm*

*Cylinders to be ordered separately:*

***115-116 series, RK6, Cross key***

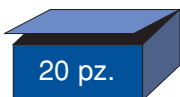



20 pz.



20 pcs.

Articolo Article	Entrata E Backset	Quote B Dimensions A		Descrizione Description	N° chiusure Nr locking point	Frontale Forend	Interasse Distance
7601P/1	25	37	40	Scrocco + catenaccio <i>Spring latch and dead bolt</i>	1	22x3 mm	85
7601P/2	30	42	45				
7601P/3	35	47	50				
7601PC/1	25	37	40	Solo catenaccio <i>Dead bolt only</i>			
7601PC/2	30	42	45				
7601PC/3	35	47	50				
7601PR/1	25	37	40	Rullo + catenacci <i>Roller latch and dead bolt</i>			
7601PR/2	30	42	45				
7601PR/3	35	47	50				
7603P/1	25	37	40	Scrocco + catenaccio <i>Spring latch and dead bolt</i>	3	22x3 mm	85
7603P/2	30	42	45				
7603P/3	35	47	50				
7603PC/1	25	37	40	Solo catenaccio <i>Dead bolt only</i>			
7603PC/2	30	42	45				
7603PC/3	35	47	50				
7603PR/1	25	37	40	Rullo + catenacci <i>Roller latch and dead bolt</i>			
7603PR/2	30	42	45				
7603PR/3	35	47	50				
7611P/1	25	37	40	Scrocco + catenaccio <i>Spring latch and dead bolt</i>	1	25x3 mm	
7611P/2	30	42	45				
7611P/3	35	47	50				
7611PC/1	25	37	40	Solo catenaccio <i>Dead bolt only</i>			
7611PC/2	30	42	45				
7611PC/3	35	47	50				
7611PR/1	25	37	40	Rullo + catenacci <i>Roller latch and dead bolt</i>			
7611PR/2	30	42	45				
7611PR/3	35	47	50				
7613P/1	25	37	40	Scrocco + catenaccio <i>Spring latch and dead bolt</i>	3	25x3 mm	
7613P/2	30	42	45				
7613P/3	35	47	50				
7613PC/1	25	37	40	Solo catenaccio <i>Dead bolt only</i>			
7613PC/2	30	42	45				
7613PC/3	35	47	50				
7613PR/1	25	37	40	Rullo + catenacci <i>Roller latch and dead bolt</i>			
7613PR/2	30	42	45				
7613PR/3	35	47	50				
7601/25GAN	25	37	40	Gancio <i>Hook deadbolt</i>	1	25x3 mm	
7601/30GAN	30	42	45				
7601/35GAN	35	47	50				
7613/25GAN	25	37	40		3		
7613/30GAN	30	42	45				
7613/35GAN	35	47	50				

Articolo Article	Entrata E Backset	Quote B Dimensions A		Descrizione Description	N° chiusure Nr locking point	Frontale Forend	Interasse Distance
7691P/1	25	37	40	Scrocco + catenaccio. Fori DIN <i>Spring latch and dead bolt. DIN Standard</i>	1	22x3 mm 	92
7691P/2	30	42	45				
7691P/3	35	47	50				
7691PC/1	25	37	40	Solo catenaccio. Fori DIN <i>Dead bolt only. DIN Standard</i>			
7691PC/2	30	42	45				
7691PC/3	35	47	50				
7691PR/1	25	37	40	Rullo + catenaccio. Fori DIN <i>Roller latch and dead bolt. DIN Standard</i>			
7691PR/2	30	42	45				
7691PR/3	35	47	50				
7693P/1	25	37	40	Scrocco + catenaccio. Fori DIN <i>Spring latch and dead bolt. DIN Standard</i>	3		
7693P/2	30	42	45				
7693P/3	35	47	50				
7693PC/1	25	37	40	Solo catenaccio. Fori DIN <i>Dead bolt only. DIN Standard</i>			
7693PC/2	30	42	45				
7693PC/3	35	47	50				
7693PR/1	25	37	40	Rullo + catenaccio. Fori DIN <i>Roller latch and dead bolt. DIN Standard</i>			
7693PR/2	30	42	45				
7693PR/3	35	47	50				
7691U/1	25	34	40	Scrocco + catenaccio. Fori DIN <i>Spring latch and dead bolt. DIN Standard</i>	1	23x6 mm 	
7691U/2	30	39	45				
7691U/3	35	44	50				
7691UC/1	25	34	40	Standard DIN Solo catenaccio. Fori DIN <i>Dead bolt only. DIN Standard</i>			
7691UC/2	30	39	45				
7691UC/3	35	44	50				
7691UR/1	25	34	40	Rullo + catenaccio. Fori DIN <i>Roller latch and dead bolt. DIN Standard</i>			
7691UR/2	30	39	45				
7691UR/3	35	44	50				

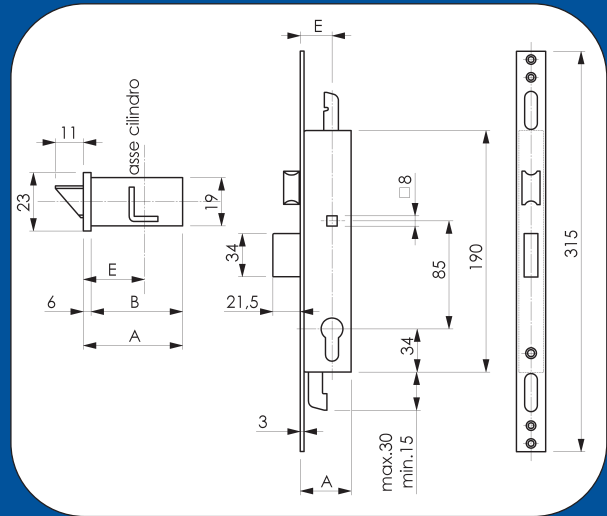





### CARATTERISTICHE

Catenaccio **avanzante**  
 Funzioni: scrocco / rullo regolabile con catenaccio, solo catenaccio  
 Reversibile  
 1 o 3 punti di chiusura  
 Asole per il **montaggio facilitato delle aste** interne / esterne  
 Coprifrontale **in acciaio inox**  
 Interasse 85 mm  
 Entrate 25, 30, 35 mm  
 Abbinabile a tutti i tipi di cilindro (opzionali):  
**Serie 115-116, RK6**

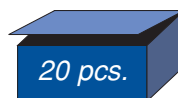
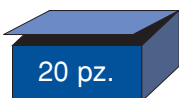
### FEATURES

Single throw dead bolt  
 Functions: spring latch / adjustable roller latch and dead bolt, dead bolt only  
 Reversible  
 1 or 3 locking points  
 Slots for **easy rod fixing**  
**Stainless steel** forend cover  
 Centre distance 85 mm  
 Backsets 25, 30, 35 mm  
 Cylinders to be ordered separately: **115-116 series, RK6**



Articolo Article	Entrata E Backset	Quote B Dimensions A		Descrizione Description	N° chiusure Nr locking point	Frontale Forend
7651P/1	25	37	40	Scrocco + catenaccio <i>Spring latch and dead bolt</i>	1	22x3 mm 
7651P/2	30	42	45			
7651P/3	35	47	50			
7651PC/1	25	37	40	Solo catenaccio <i>Dead bolt only</i>		
7651PC/2	30	42	45			
7651PC/3	35	47	50			
7651PR/1	25	37	40	Rullo + catenacci <i>Roller latch and dead bolt</i>		
7651PR/2	30	42	45			
7651PR/3	35	47	50			
7653P/1	25	37	40	Scrocco + catenaccio <i>Spring latch and dead bolt</i>	3	22x3 mm 
7653P/2	30	42	45			
7653P/3	35	47	50			
7653PC/1	25	37	40	Solo catenaccio <i>Dead bolt only</i>		
7653PC/2	30	42	45			
7653PC/3	35	47	50			
7653PR/1	25	37	40	Rullo + catenacci <i>Roller latch and dead bolt</i>		
7653PR/2	30	42	45			
7653PR/3	35	47	50			
7655P/1	25	37	40	Scrocco + catenaccio <i>Spring latch and dead bolt</i>	1	25x3 mm 
7655P/2	30	42	45			
7655P/3	35	47	50			
7655PC/1	25	37	40	Solo catenaccio <i>Dead bolt only</i>		
7655PC/2	30	42	45			
7655PC/3	35	47	50			
7655PR/1	25	37	40	Rullo + catenacci <i>Roller latch and dead bolt</i>		
7655PR/2	30	42	45			
7655PR/3	35	47	50			
7658P/1	25	37	40	Scrocco + catenaccio <i>Spring latch and dead bolt</i>	3	25x3 mm 
7658P/2	30	42	45			
7658P/3	35	47	50			
7658PC/1	25	37	40	Solo catenaccio <i>Dead bolt only</i>		
7658PC/2	30	42	45			
7658PC/3	35	47	50			
7658PR/1	25	37	40	Rullo + catenacci <i>Roller latch and dead bolt</i>		
7658PR/2	30	42	45			
7658PR/3	35	47	50			

# DOPPIA MAPPA

Serratura da montante a doppia mappa a 1-3 punti di chiusura

Multilever narrow style lock 1 or 3 locking points

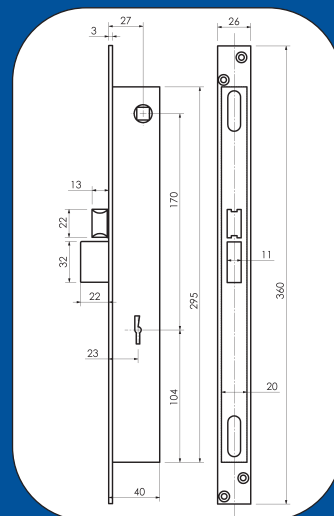

## CARATTERISTICHE

Funzioni: scrocco / rullo regolabile con catenaccio, solo catenaccio  
 Reversibile  
 1 o 3 punti di chiusura  
 Catenaccio a 2 mandate  
 Coprifrontale in acciaio inox 26x3mm

## FEATURES

Functions: spring latch / adjustable roller latch with dead bolt, dead bolt only  
 Reversible  
 1 or 3 locking points  
 2 throws dead bolt  
 Stainless steel forend cover 26x3 mm

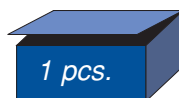
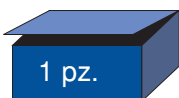

# DOPPIA MAPPA

La gamma

Range

Articolo Article	Descrizione Descrizione	N° chiusure Nr locking point	Nota Note
6601	Scrocco + catenaccio Spring latch and dead bolt	1	Con incontro Striking plate included
6601C	Solo catenaccio Dead bolt only		
6601R	Rullo + catenaccio Roller and dead bolt		
6603	Scrocco + catenaccio Spring latch and dead bolt	3	Senza incontro Striking plate excluded
6603C	Solo catenaccio Dead bolt only		
6603R	Rullo + catenaccio Roller and dead bolt		

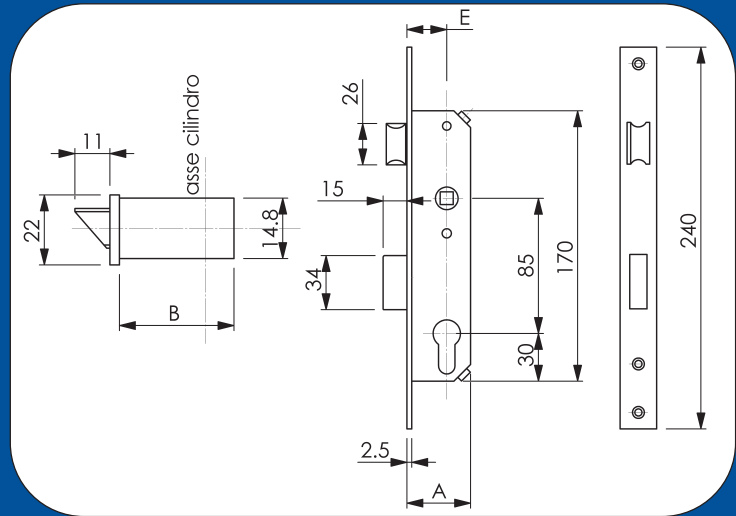

### CARATTERISTICHE

Funzioni: scrocco / rullo regolabile con catenaccio  
 Catenaccio **monomandata maggiorata di 15mm**  
 Reversibile  
 Frontale in **acciaio inox, removibile**  
 Interasse 85 mm  
 Entrate 20, 25, 30, 35 mm  
 Con incontro piatto 22x3 mm in acciaio  
 Abbinabile a tutti i tipi di cilindro (opzionali):  
**Serie 115 - 116, RK6**

### FEATURES

Functions: spring latch / adjustable roller latch with  
 dead bolt  
 Single throw dead bolt **15mm**  
 Reversible  
**Stainless steel removable** forend  
 Centre distance 85 mm  
 Backsets 20, 25, 30, 35 mm  
 Flat striking plate 22x3 mm included  
 Cylinders to be ordered separately:  
**115-116 series, RK6**

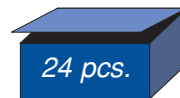
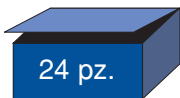

Articolo Article	E Entrata Backset	B	Quote Dimensions	A	Descrizione Description
7661	20	32,5	35		Scrocco + catenaccio Spring latch and dead bolt
7661/1	25	37,5	40		
7661/2	30	42,5	45		
7661/3	35	47,5	50		
7661R	20	32,5	35		Rullo + catenaccio Roller latch and dead bolt
7661R/1	25	37,5	40		
7661R/2	30	42,5	45		
7661R/3	35	47,5	50		

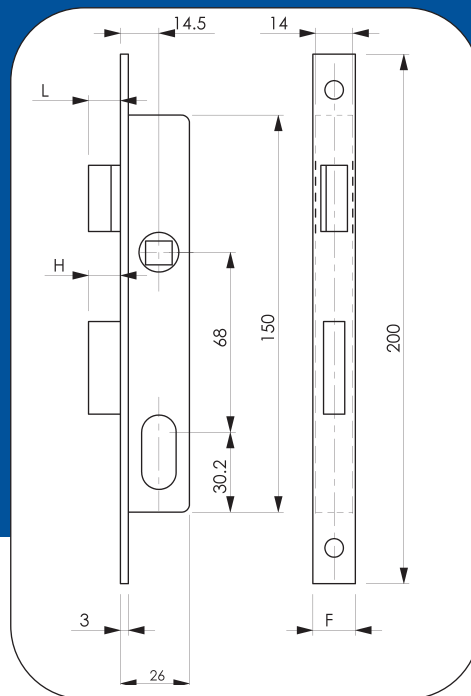
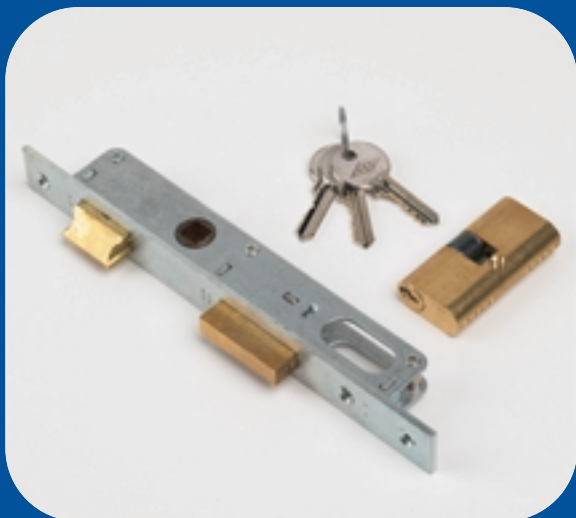

### CARATTERISTICHE

Funzioni: scrocco / rullo regolabile con catenaccio  
Catenaccio monomandata  
Reversibile  
Frontale 16 e 20 mm

### FEATURES

Functions: spring latch / adjustable roller with dead bolt  
Single throw dead bolt  
Reversible  
Forend 16 and 20 mm

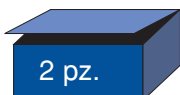

2 pz.

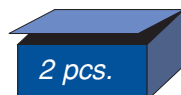

2 pcs.

Articolo Article	Quote Dimensions			Descrizione Description
	F	L	H	
6560	16	12	12	Scrocco + catenaccio Spring latch and dead bolt
6561	20	12	12	
6570	16	-	12	Rullo + catenaccio Roller latch and dead bolt
6571	20	-	12	



### CARATTERISTICHE

Solo rullo regolabile  
Solo scrocco reversibile, azionato dal cilindro  
Solo catenaccio  
Solo scrocco reversibile, azionato dalla maniglia

### FEATURES

Adjustable roller only  
Reversible spring latch by cylinder  
Dead bolt only  
Reversible spring latch by handle

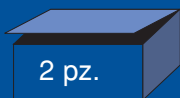

Articolo Article	Quote Dimension F	Descrizione Description		
6520	16	Rullo Roller latch		
6521	20			
6530	16	Scrocco (tramite cilindro) Spring latch by cylinder		
6531	20			
6540	16	Solo catenaccio Dead bolt only		
6541	20			
6550	16	Scrocco (tramite maniglia) Spring latch by handle		
6551	20			

### CARATTERISTICHE

Solo catenaccio avanzante  
Solo gancio  
Solo catenaccio basculante  
Con incontro in acciaio

### FEATURES

Dead bolt only  
Hook dead bolt only  
Tilting dead bolt only  
Striking plate included

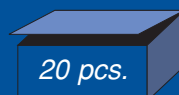
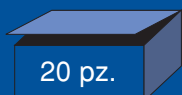

Articolo Article	Descrizione Description		
5810	Catenaccio avanzante, frontale 16 mm. 3 chiavi <i>Dead bolt, forend 16 mm with 3 keys</i>		
5811	Catenaccio avanzante, frontale 20 mm. 3 chiavi <i>Dead bolt, forend 20 mm with 3 keys</i>		
5815	Gancio. 3 chiavi <i>Hook dead bolt with 3 keys</i>		
5820	Catenaccio basculante. 3 chiavi <i>Tilting dead bolt with 3 keys</i>		